

FITTING INSTRUCTION

| Clamp mark in acc. with | | Cables joining |
|-------------------------|-----|---------------------------|
| ISO | PN | |
| 1 | L | Left directional lights |
| 2 | + | Rear fog lights |
| 3 | 31 | Ground |
| 4 | R | Right directional lights |
| 5 | 58R | Right side parking lights |
| 6 | 54 | Stoplights |
| 7 | 58L | Left side parking lights |

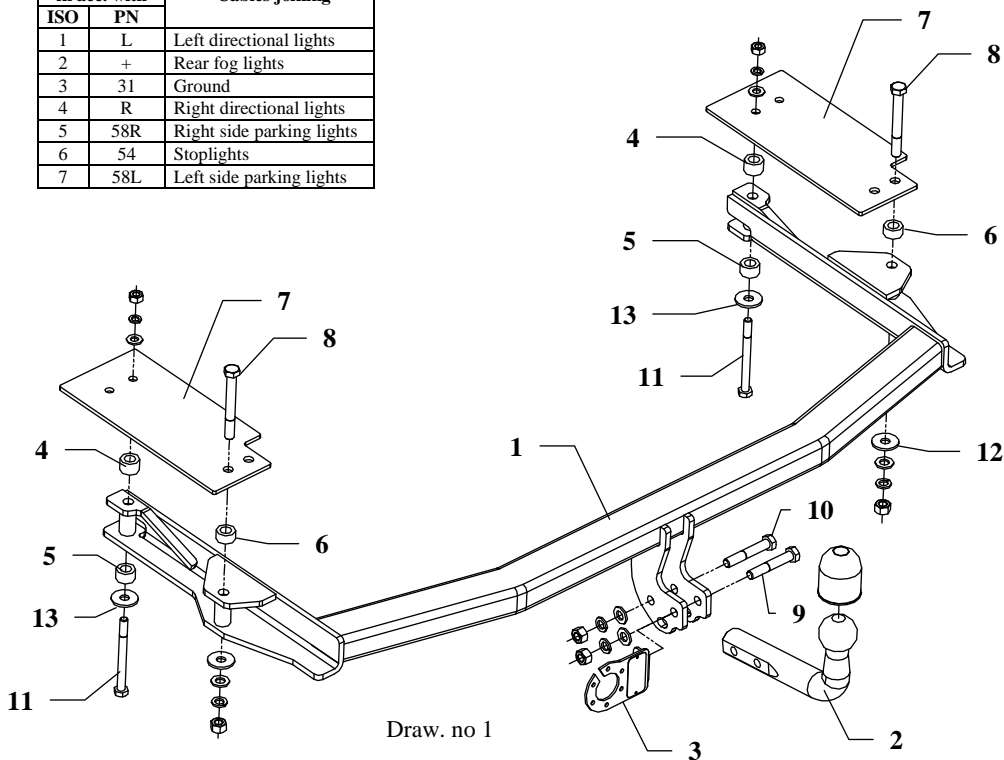

Draw. no 1

This towbar is designed to assembly in following cars:
Mazda 6, 4/5 doors (GG), except MPS produced since 07.2002 till 02.2008, catalogue number **M49** and is prepared to tow trailers **max total weight 1600 kg** and **max vertical load 75 kg**.

From manufacturer

Thank you for buying our product. Their reliability has been confirmed in many tests. Reliability of towbar depends also on correct assembly and right operation. For this reasons we kindly ask to read carefully this instruction and apply to hints.

The towbar should be install in points described by a car producer.

The instruction of the assembly

1. Disassemble the bumper and metal reinforcement. From the rear handler get lower the muffler and rivet out the thermal shield.
2. In back wall make holes 85x60mm to make way to the longitudinal members.(use template right and left)
3. Original made holes in members A, B, C boring with drill $\varnothing 25\text{mm}$ as shown on the drawing no. 2.
4. Put main bar of the towing hitch (pos. 1) in longitudinal members according to the holes in both elements.
5. To drilled holes $\varnothing 25\text{mm}$ put sleeves as shown on the drawing no. 1.
6. Place fish-plates (pos. 7) and fix it as shown at the drawing no. 1.
7. After cut out fragments of bumper (see template), reassemble the bumper and thermal shield (see drawing no. 3).

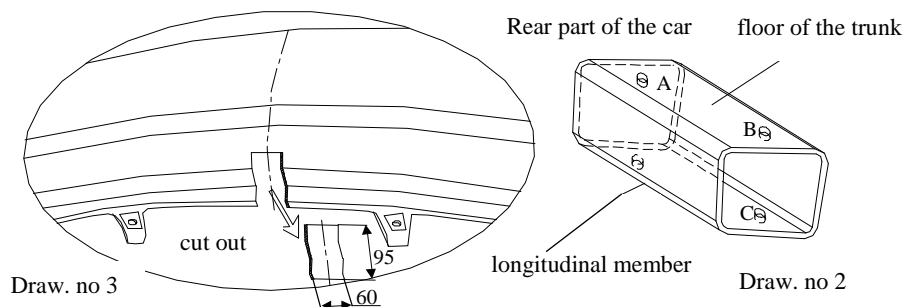

Draw. no 3

Draw. no 2

8. Fix the tow ball (pos. 2) together with a socket plate (pos. 3) using bolts M12x75mm (pos. 9) and M12x70mm (pos. 10) from equipment.
9. Tighten all bolts according to the torque shown in the table.
10. Connect the electric wires according to the instructions of the car. (Recommended to make at service station)
11. Complete paint layer damaged during installation.

Torque settings for nuts and bolts (8,8):

| | | |
|--------------------|---------------------|---------------------|
| M6 - 11 Nm | M8 - 25 Nm | M10 - 50 Nm |
| M12 - 87 Nm | M14 - 138 Nm | M16 - 210 Nm |











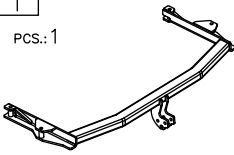

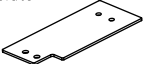

NOTE

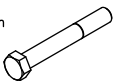
After install the towbar you should get adequate note in registration book (at authorised service station). The car should be equipped with:

- Indicators
- Tow mirrors

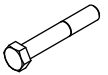
After 1000km check all bolts and nuts. The ball of towbar must be always kept clear and conserve with a grease.

Equipment of towing hitch:

| | | | |
|---|---|---|--|
| Pos. 1 Main bar PCS.: 1 | Pos. 5 Distance sleeve L=15mm PCS.: 2 | Pos. 10 Bolt 8,8 B M12x70mm PCS.: 1 | Pos. 15 Plain washer ø10mm PCS.: 2 |
|  | Pos. 6 Distance sleeve L=13mm PCS.: 2 | Pos. 11 Bolt 8,8 B M10x110 PCS.: 2 | Pos. 16 Spring washer ø12mm PCS.: 4 |
| Pos. 2 Tow ball PCS.: 1 | Pos. 7 Fish-plate PCS.: 2 | Pos. 12 Washer ø37xø13x3mm PCS.: 2 | Pos. 17 Spring washer ø10mm PCS.: 2 |
|  |  |  |  |
| Pos. 3 Socket plate PCS.: 1 | Pos. 8 Bolt 8,8 B M12x100mm PCS.: 2 | Pos. 13 Washer ø30xø10,5x2,5mm PCS.: 2 | Pos. 18 Nut 8 B M12 PCS.: 4 |
|  |  |  |  |
| Pos. 4 Distance sleeve L=17mm PCS.: 2 | Pos. 9 Bolt 8,8 B M12x75mm PCS.: 1 | Pos. 14 Plain washer ø12mm PCS.: 4 | Pos. 19 Nut 8 B M10 PCS.: 2 |
|  |  |  |  |
| | | Pos. 20 Ball's cover PCS.: 1 |  |



PPUH AUTO-HAK Sp.J.

Produkcja Zaczepów Kulowych
Henryk & Zbigniew Nejman
76-200 SŁUPSK ul. Słoneczna 16K
tel/fax (059) 8-414-414; 8-414-413
E-mail: office@autohak.com.pl
www.autohak.com.pl

Towing hitch (without electrical set)

Class: **A50-X** Cat. no. **M49**

Designed for:

Manufacturer: **MAZDA**

Model: **series 6**

Type: **4/5 doors (GG), except MPS**

produced since 01.2003 till 01.2008

Technical data:

D-value: 8,7 kN

maximum trailer weight: **1600 kg**

maximum vertical cup load: **75 kg**

Approval number acc. to regulations EKG/ONZ 55.01: E20-55R-01 0921

Foreword

This towing hitch is designed according to rules of safety traffic regulations. The towing hitch is a safety component and can be install only by qualified personnel. Any alteration or conversion of the towing hitch is prohibited and would lead to cancellation of design certification. Remove insulating compound and underseal from vehicle (if present) in the area of the matting surfaces of the towing hitch.

The vehicle manufacturer's specifications regarding trailer load and max. vertical cup load are decisive for driving whereat values for the towing hitch cannot be exceeded.

D-value formula:

$$\frac{\text{Max trailer weight [kg]} \times \text{Max vehicle weight [kg]}}{\text{Max trailer weight [kg]} + \text{Max vehicle weight [kg]}} \times \frac{9,81}{1000} = D \text{ [kN]}$$

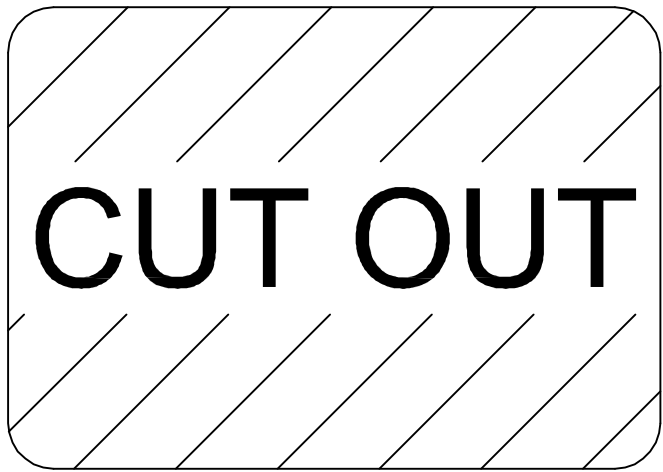

Left

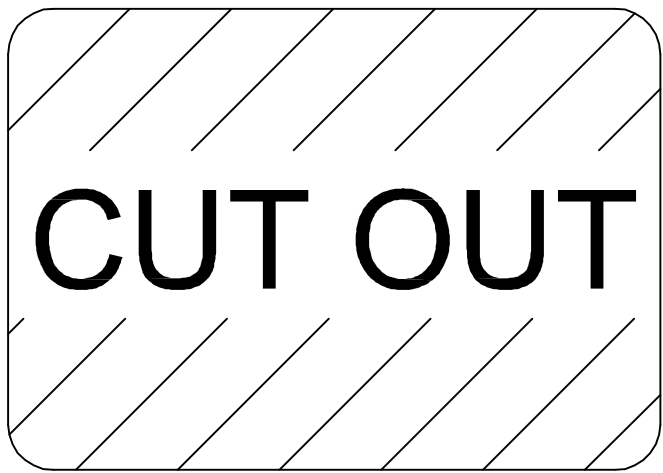

Right