

# Инструкция по установке

## LADA 4x4

(1995-)



Арт.: F.6014.004

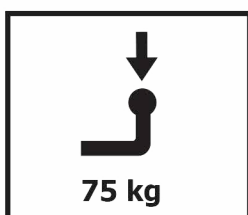
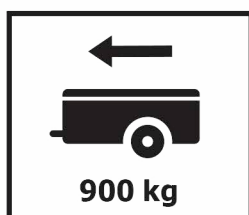

$D = 5,94 \text{ kN}$

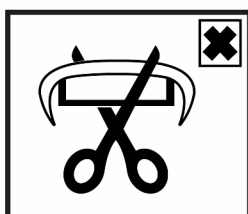

$$D \text{ (kN)} = \frac{\text{MAX kg} \times \text{MAX kg}}{\text{MAX kg} + \text{MAX kg}} \times 0,00981$$

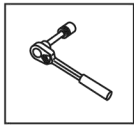

Вкрутить/выкрутить используя инструмент

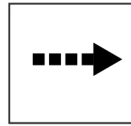

Движение

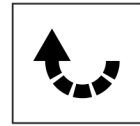

Поворот



Вкрутить/выкрутить не затягивая

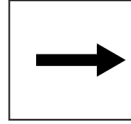





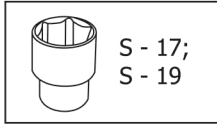
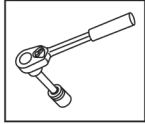



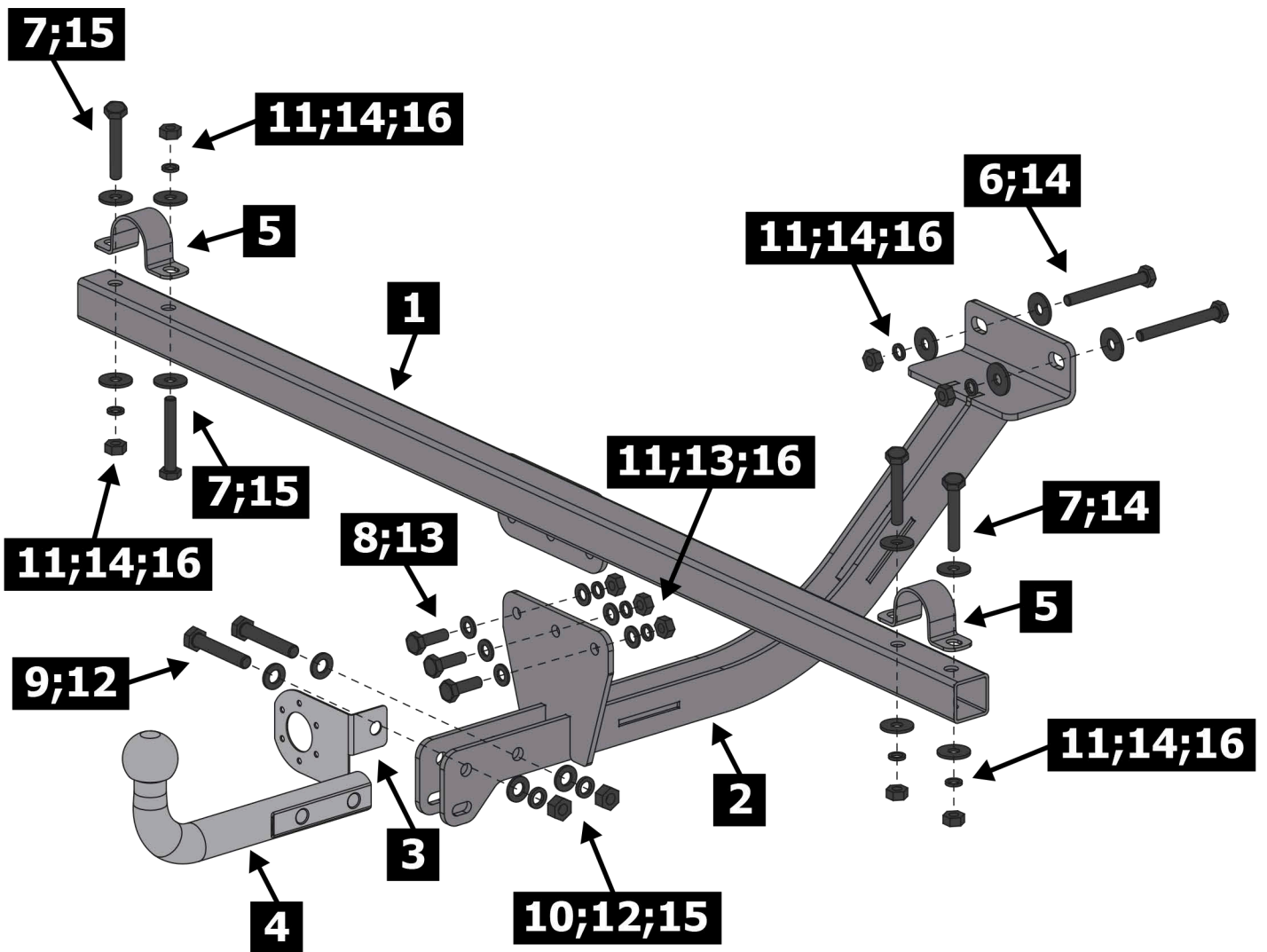

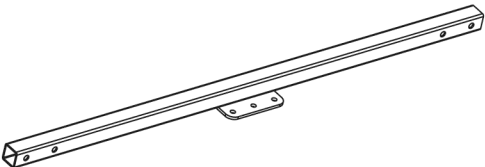
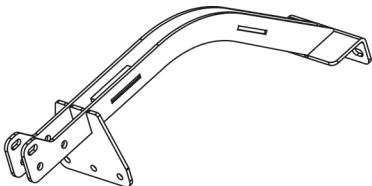
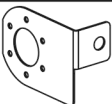
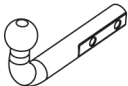
Расположение

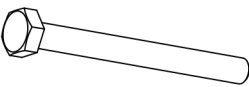
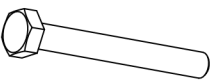
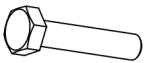
### Используемый инструмент:

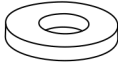

S - 17;  
S - 19



<b>1</b>	x1	Балка	
<b>2</b>	x1	Кронштейн	
<b>3</b>	x1	Подрозетник	
<b>4</b>	x1	Крюк	
<b>5</b>	x2	Скоба	
<b>6</b>	x2	M10x90	
<b>7</b>	x4	M10x70	
<b>8</b>	x3	M10x35	
<b>9</b>	x2	M12x70	
<b>10</b>	x2	∅ 12	
<b>11</b>	x9	∅ 10	
<b>12</b>	x4	∅ 12	
<b>13</b>	x6	∅ 10	
<b>14</b>	x12	∅ 10	
<b>15</b>	x2	M12	
<b>16</b>	x9	M10	

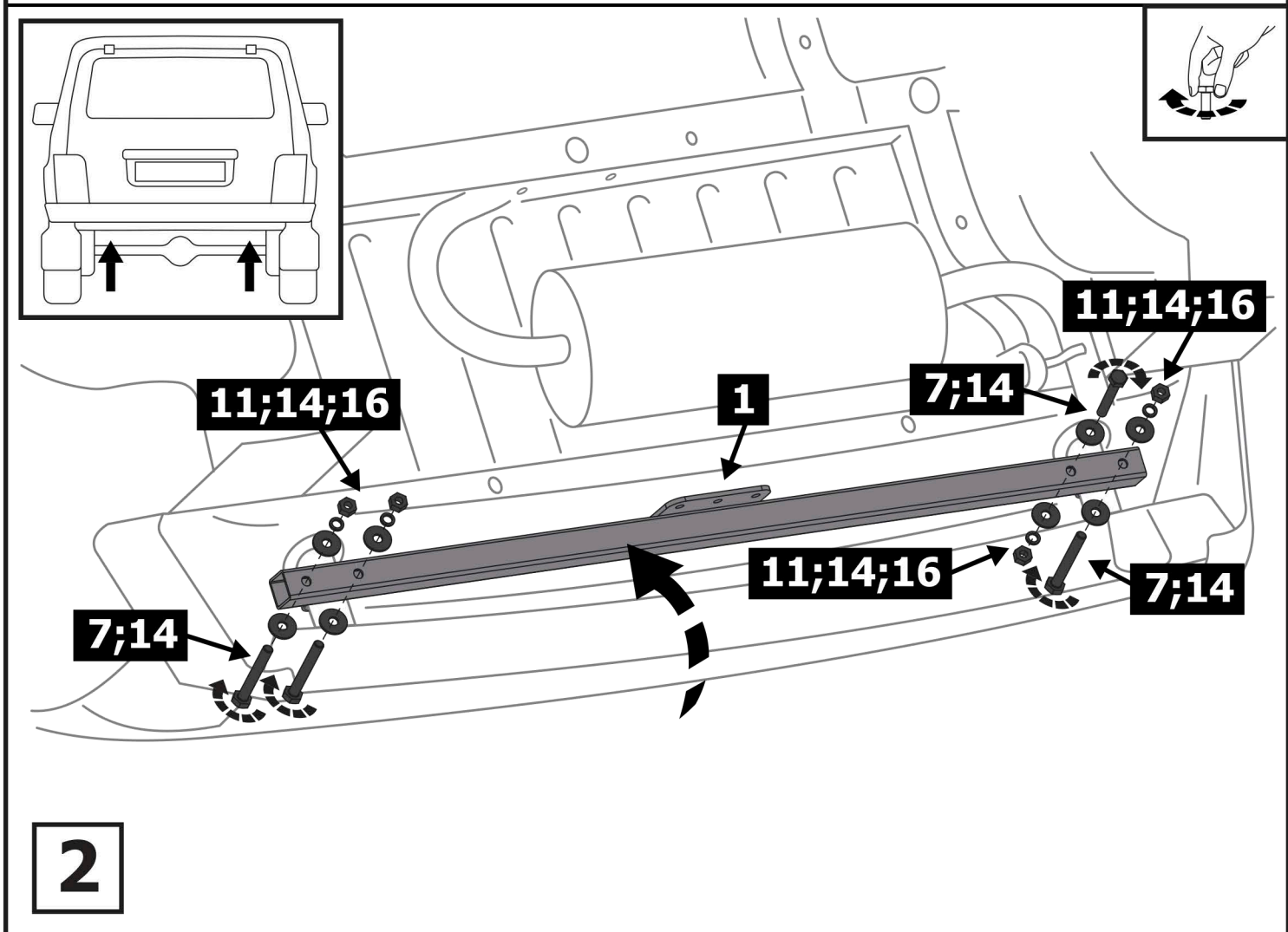
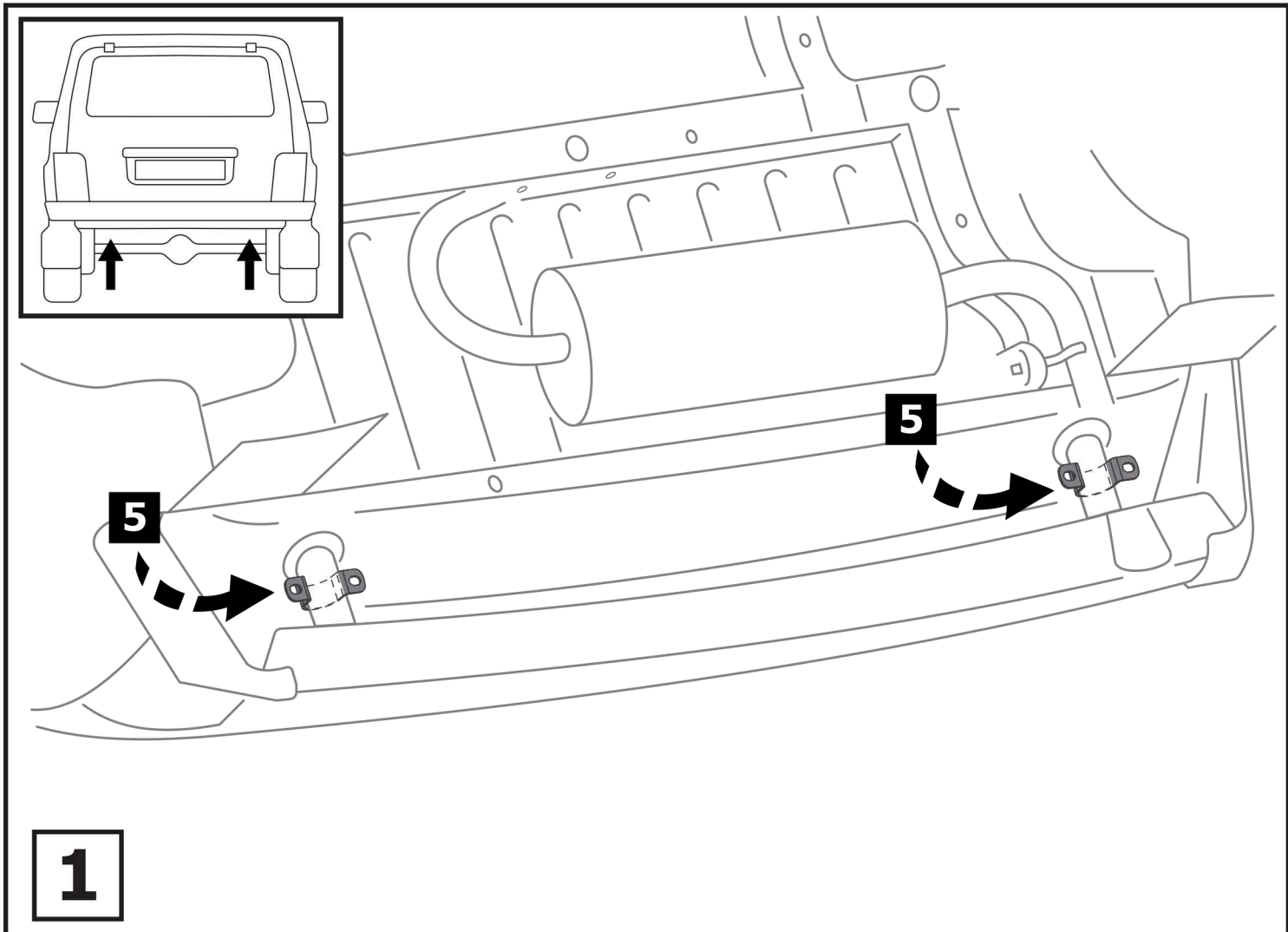

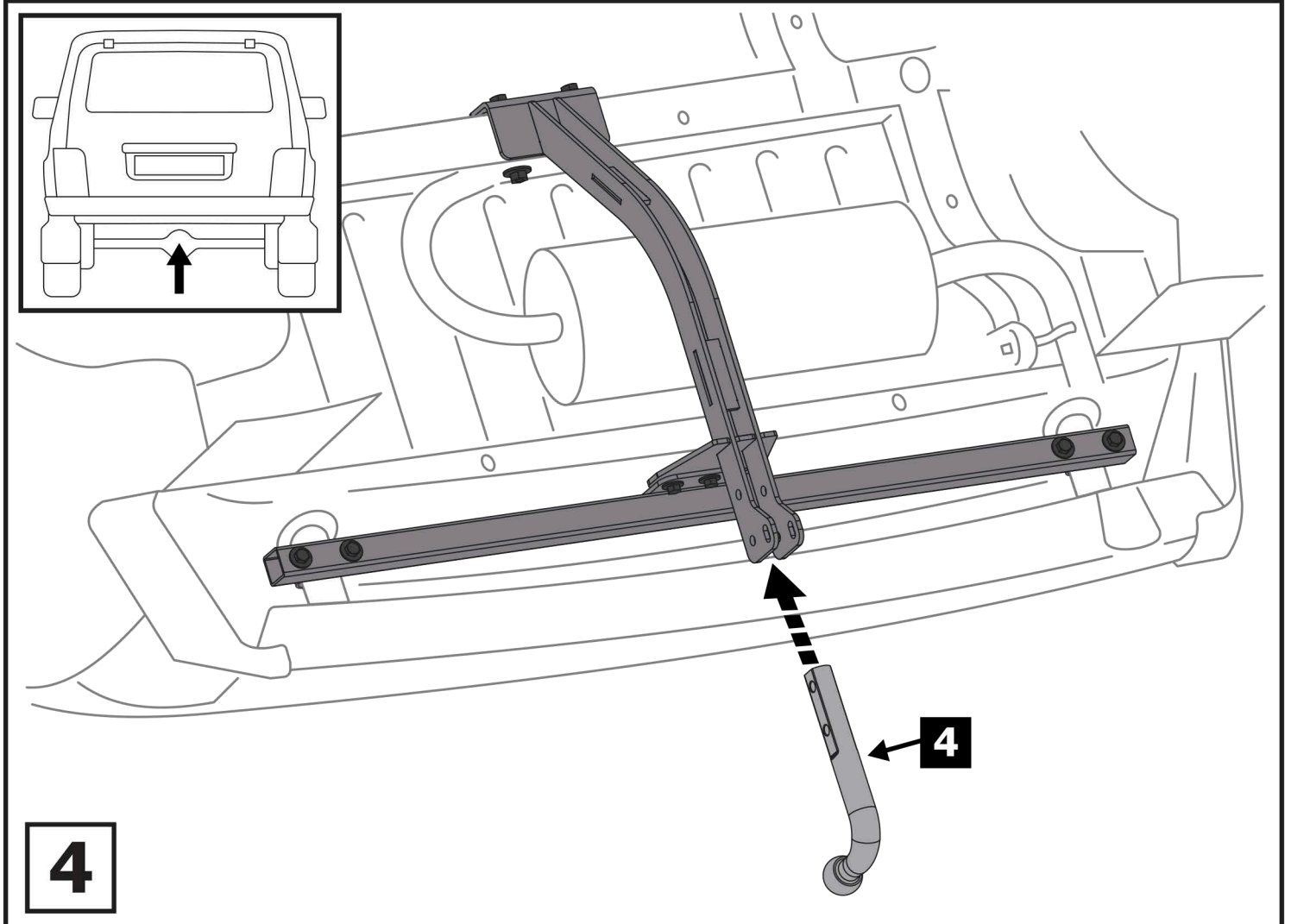
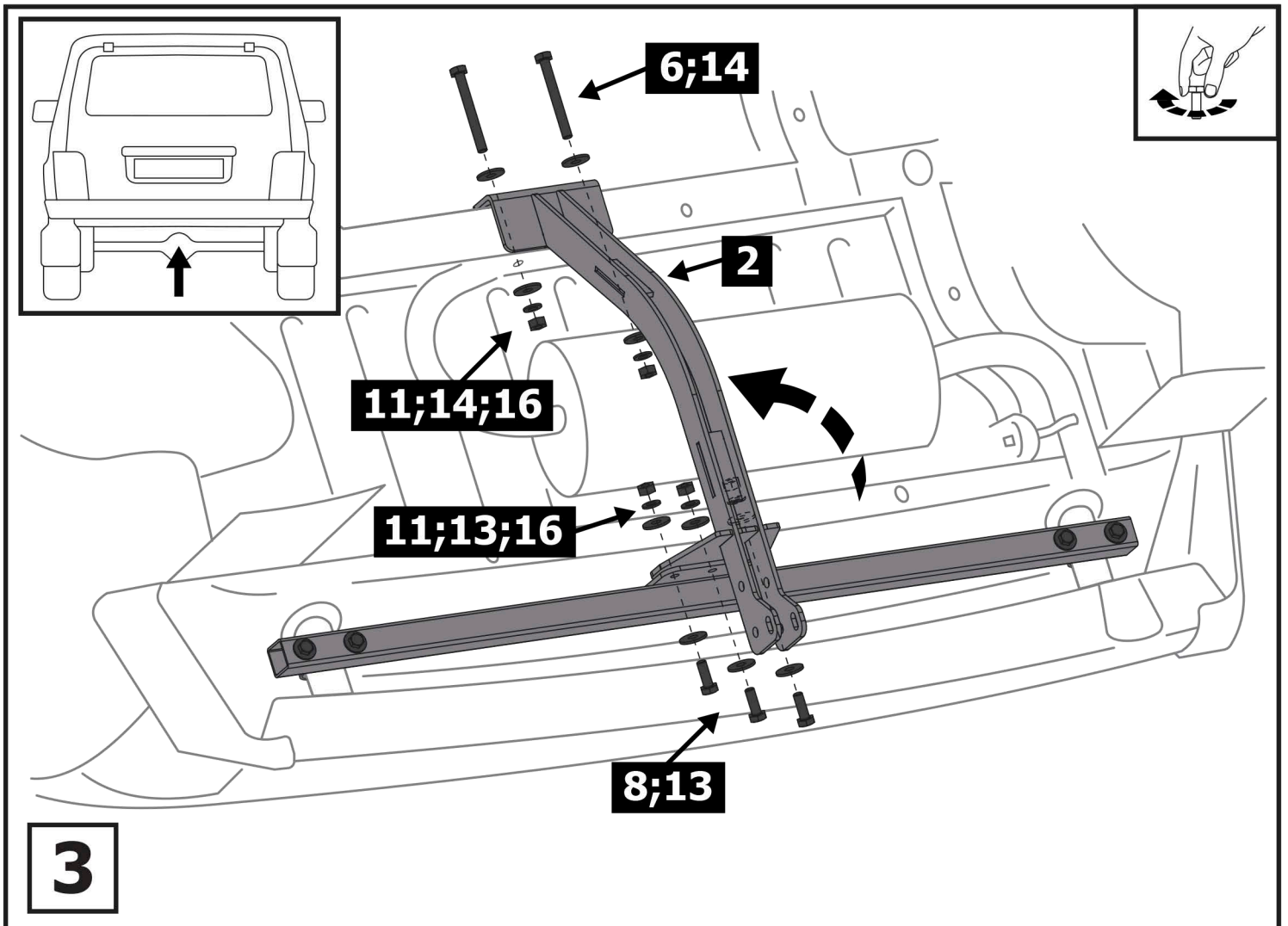

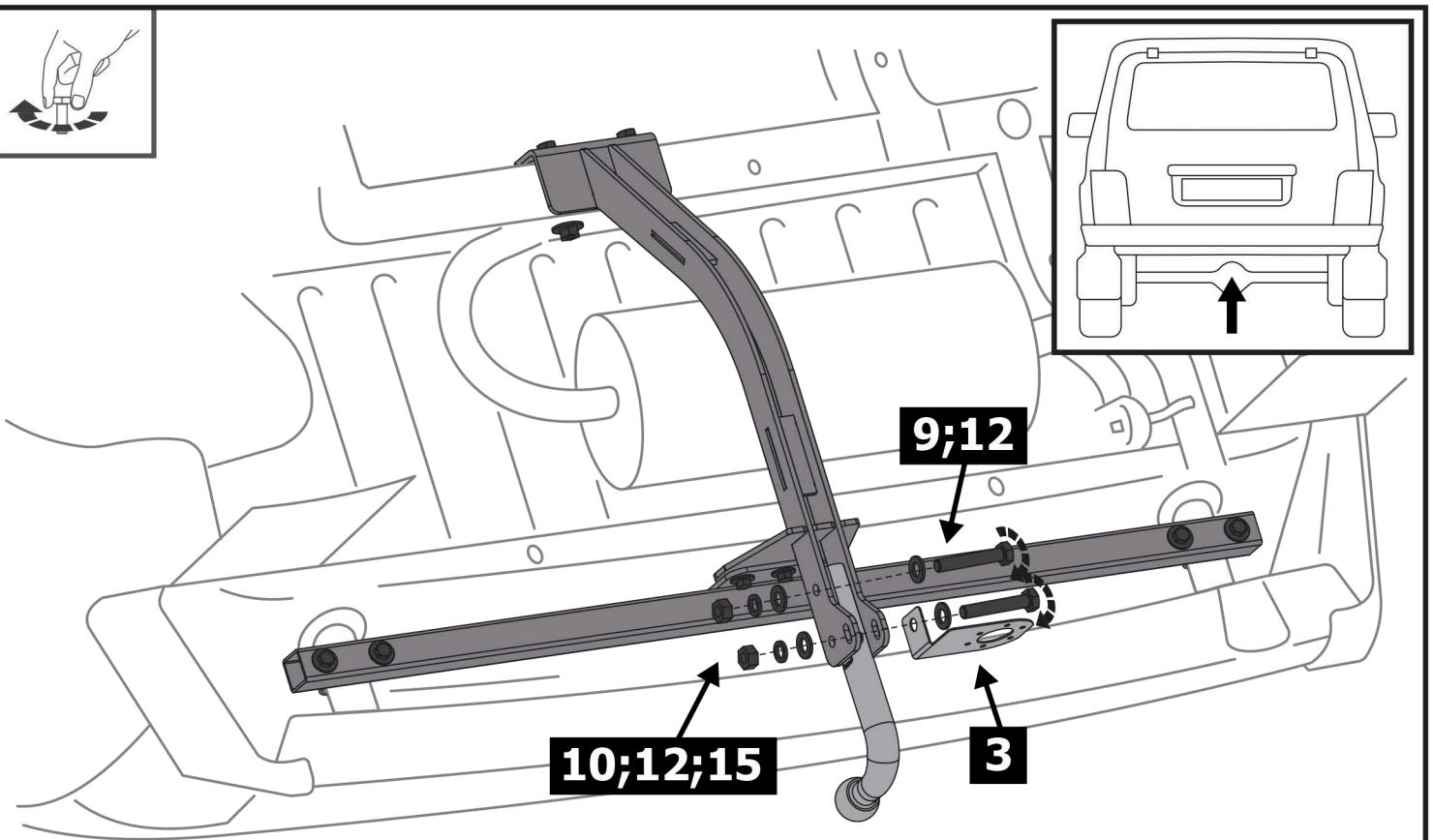
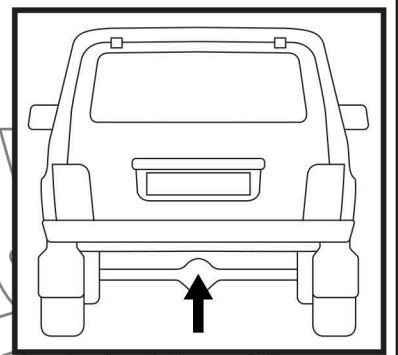

**5**

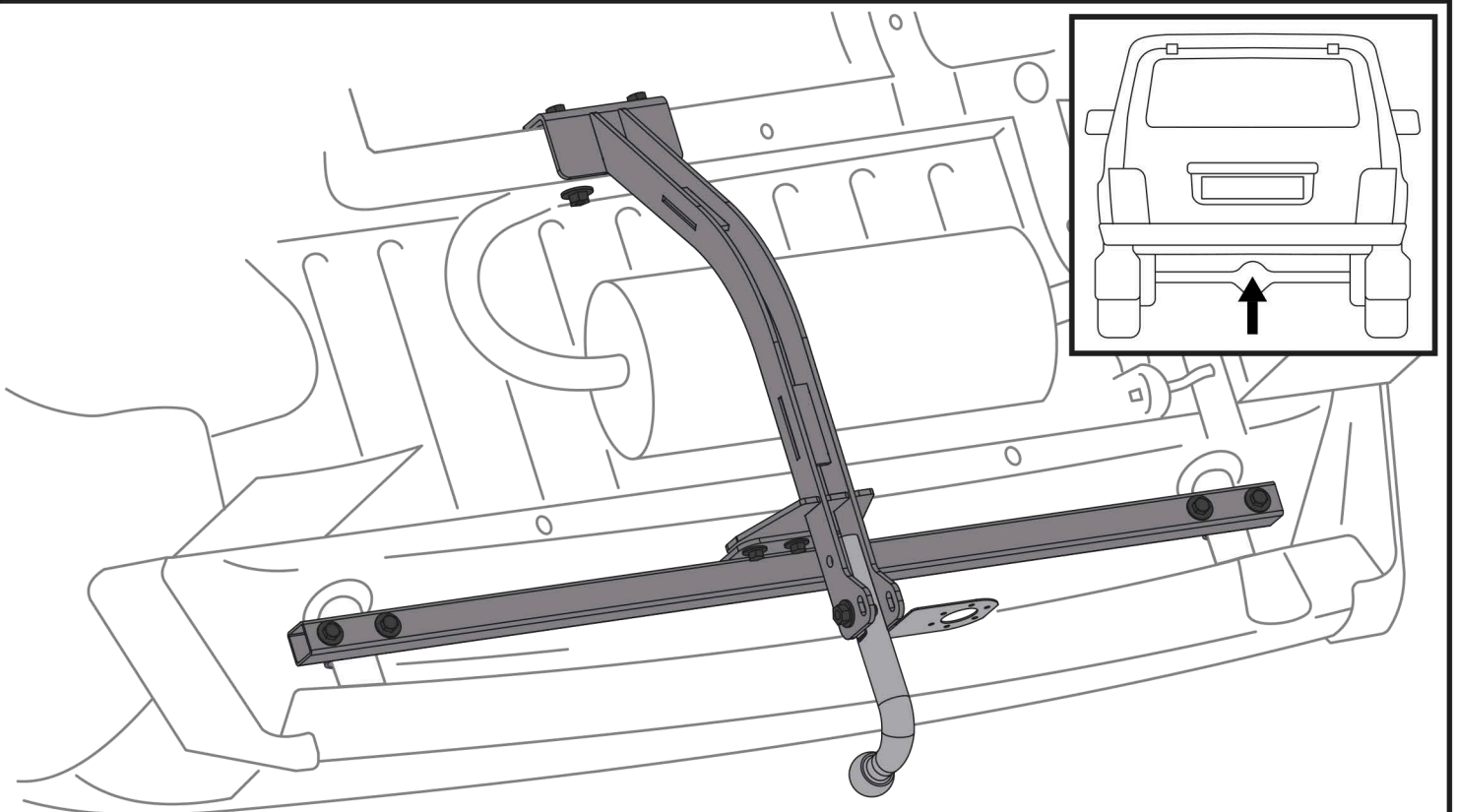
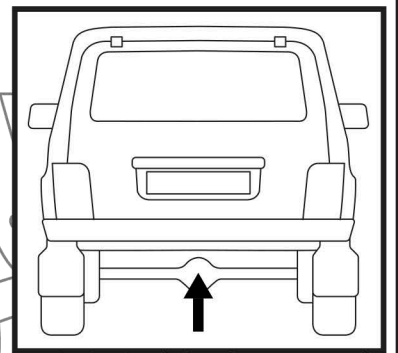

**6**

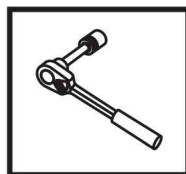

**Затянуть все резьбовые соединения**  
**M10 = 47 Nm    M12 = 81 Nm**